

MONTAŻ SYSTEMU ZD2

z agrafką

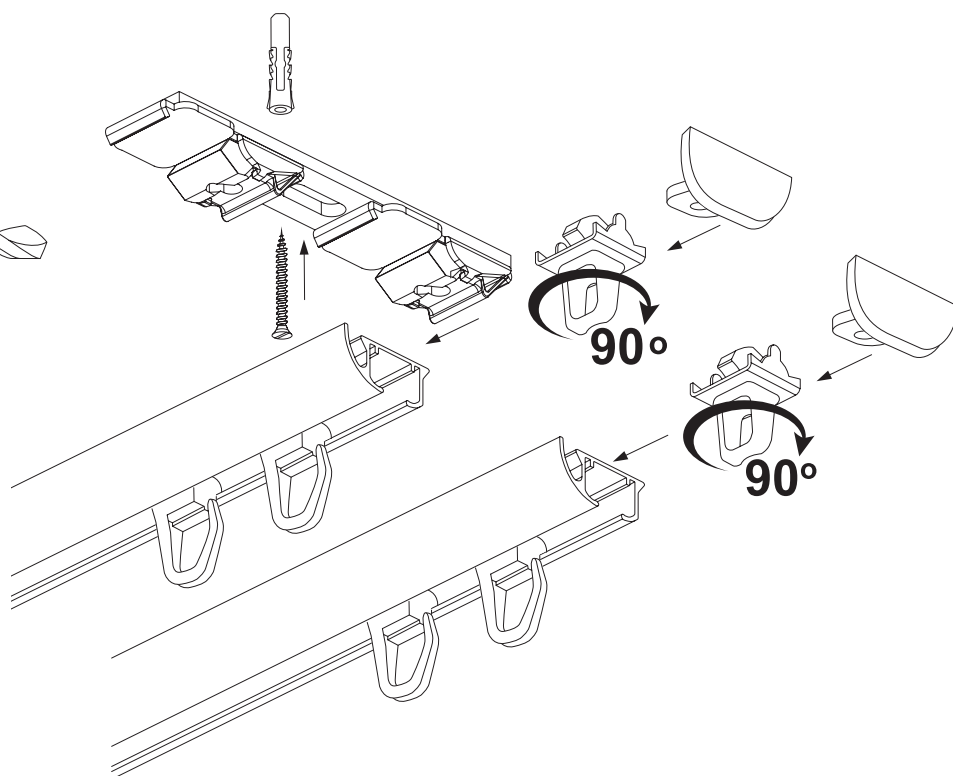

Φ 6 mm



MONTAŻ SYSTEMU ZD2

z żabką



Φ 6 mm

